

Multipendant LED Lamp

MP10305

INSTALLATION SHEET

START FROM HERE

- Make sure **POWER** is **COMPLETELY OFF** at the fuse box
- Have your fixture installed by a qualified licensed electrician
- Prepare everything in a clear area
- Wear gloves at all time during this installation
- Read instructions carefully before you start assembly
- Keep this installation sheet for future reference

Please Note:

- All Kuzco LED fixtures come with pre-wired LED module(s).
- Unless instructed to do so, please do not touch any part of the LED module(s) as any unnecessary contact with the module could cause permanent damage.
- For dimming, an ELV (Electronic Low Voltage) type of dimmer is required.

CAUTION: HEAVY FIXTURE, THE JUNCTION BOX NEEDS TO BE REINFORCED BEFORE INSTALLATION.

Technical Support: 1-855-855-8926

- 1.** Remove the fixture from it's original packaging. Remove the canopy mounting plate (**1d**) from within the canopy (**2a**) by removing the decorative nuts (**2b**). Secure the mounting plate (**1d**) to the reinforced junction box (**1a**) with screws (**1g**). For additional support add four wood (**1f**) screws to plastic anchors (**1c**) in the ceiling.
- 2.** Attach the fixture to the mounting plate, which is attached to the electrical junction box on the ceiling. First connect all wires correctly G ground to ground, N neutral wire (white to white), L live wire (black to black) with provided marettes (**1b**) from the hardware package. Align the threaded studs (**1e**) hanging downward from the mounting plate (**1c**) to the holes inside the canopy (**2a**). Push the canopy (**2a**) up towards the ceiling so the threaded studs (**1e**) clears through the holes in the canopy (**2a**). Next, thread the decorative nuts (**2b**) this will secure the canopy (**2a**) to the mounting plate (**1c**).
- 3.** Set the fixture hanging height (120" maximum), loosen the wire lock nut (**2c**) at the canopy (**2a**) where the wire comes out from. Push the wire up to shorten, or pull the wire down to lengthen. When you have selected your desired length, just tighten back the nut (**2c**) and the wire will be held tightly in place. (**Note:** includes two hooks with thin cables to temporarily suspend the fixture about a foot and a half below the ceiling).
- 4.** You have now completed the installation of your fixture, enjoy.

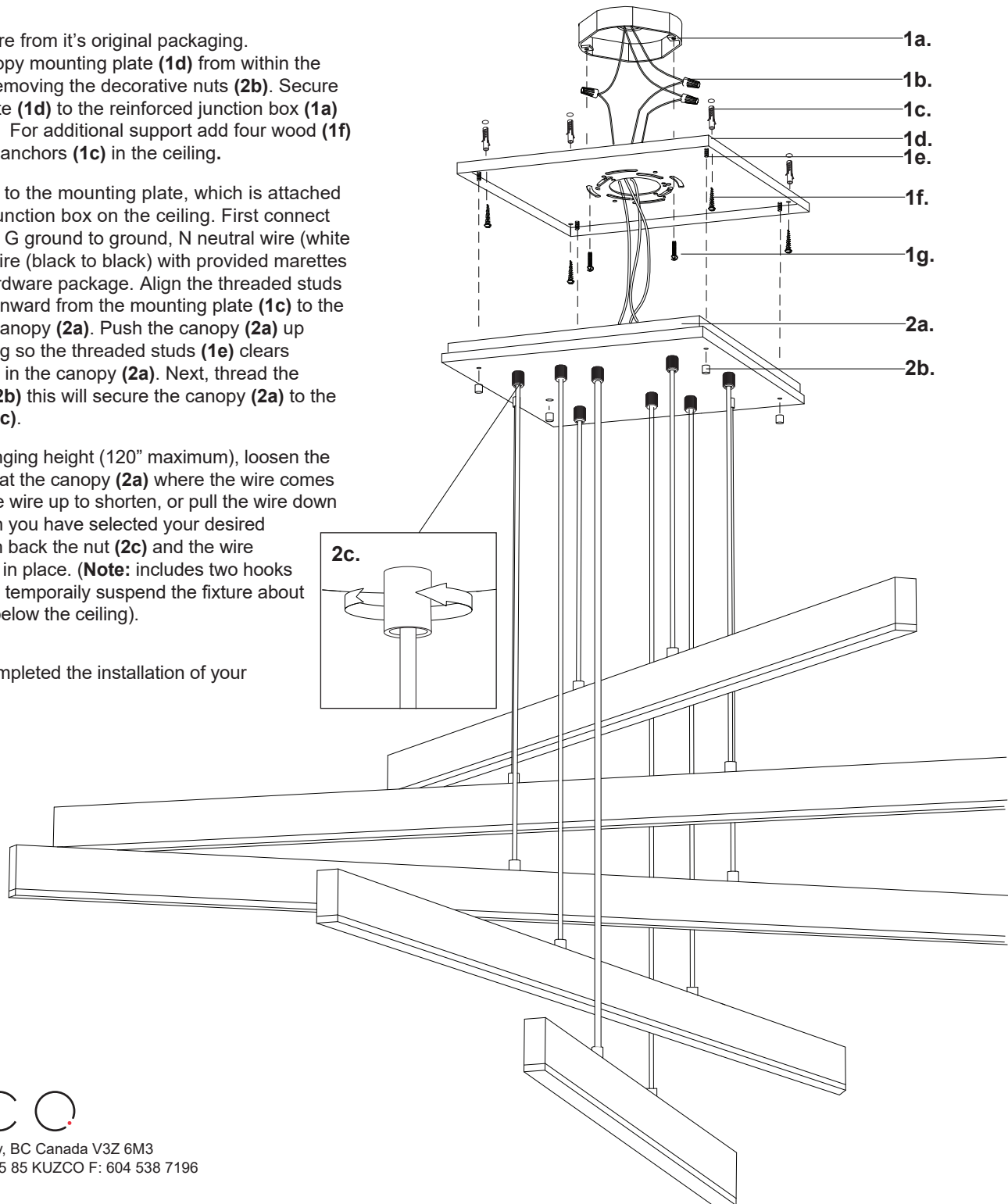

KUZCO

19054 28th Avenue Surrey, BC Canada V3Z 6M3
T: 604 538 7162 TF: 1-855 85 KUZCO F: 604 538 7196
W: kuzcolighting.com
20181127